

Steelcase Roam



Availability

Electronic price list updated with release 190.A (U.S.) and 151.A (Canada), dated April 15, 2019.

Spec News is available on village.steelcase.com. Search Steelcase Marketing Resources (Adstock) and download the current release's Spec News.

Tip: Steelcase Marketing Resources is a new global platform for ordering Steelcase marketing materials that replaces Adstock.

View or download Steelcase Specification Guides at [https://www.steelcase.com/resources/documents?tax-\[doctype\]=spec-guide](https://www.steelcase.com/resources/documents?tax-[doctype]=spec-guide).

Transitional products in this specification guide are **maintained for existing customers only** and are likely to be phased out over time. These products are indicated with a . Products that are scheduled to be culled are indicated with an , followed by the last order entry date.

Surface Materials

The surface materials team has announced the launch of the Finish Library, found at <http://finishlibrary.steelcase.com>.

► For a list of all trademarks, refer to the last page of this specification guide.
© 2019 Steelcase Inc.



For Canadian Pricing

Canadian factor can be found at steelcase.com/CADpricing.

Calculate in the following order to avoid rounding errors:

- Multiply the base price and each option by the Canadian factor.
- Round each to the nearest dollar.
- Add base and options for total list price.

Product Details

Roam for Microsoft Surface Hub 2 **2**

Specifying

Roam Mobile Stand for Microsoft Surface Hub 2 **4**

Roam Single Wall Mount for Microsoft Surface Hub 2 **5**

Roam Mobile Stand for Microsoft Surface Hub 2

Roam mobile stand is designed to help people collaborate anywhere, including more open and casual spaces, in whatever way works for them.
 ▶ Specifying, page 4

Tray lid is a water repellent material designed to protect against spills and stains.

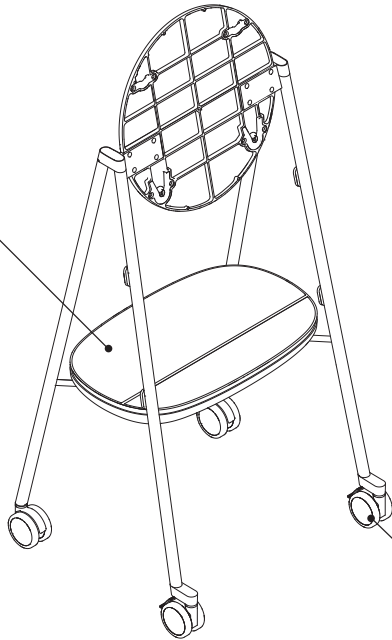

Mobile stand includes 360° rotating casters. Front casters are locking and back casters are non-locking.

Product Details

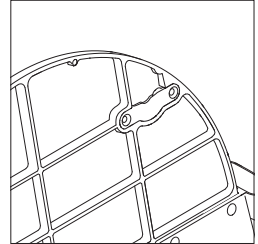

Seismic locking system allows for the device to be easily placed on the mobile stand and automatically locks in place.

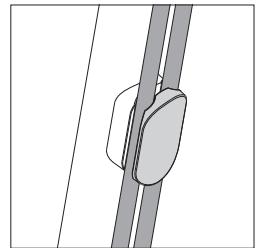

A cord management system allows different power and data cords to easily be secured on each leg.

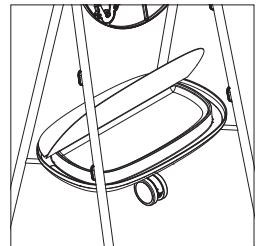

A storage tray is included to house cords or other items, such as a keyboard, when being transported.

A foam eraser can be used to clean leg surfaces.

Surface Materials

Stand

- 7241 Arctic White

Mount

- 7470 Microsoft Grey

Tray

- 3549/804 Pewter, Billiard Cloth

Actual Dimensions

Overall height	65 ² / ₅ "
Dimension of base	30 ² / ₅ " x 26 ¹ / ₂ "
Weight (without device)	62 lb

Roam Single Wall Mount for Microsoft Hub 2

Roam Single Wall Mount for
Microsoft Hub 2

Roam single wall mount for Microsoft Hub 2

is designed for easy installation on drywall, with no additional support brackets.

► Specifying, page 5

Tip: Wall mount is for installation on drywall. If installing on other surfaces, discuss with responsible trades.

Seismic locking system allows for the device to be easily placed on the single wall mount and automatically locks in place.

Roam single wall mount keeps the Hub 2 close to the wall (ADA compliant) and installs in minutes.

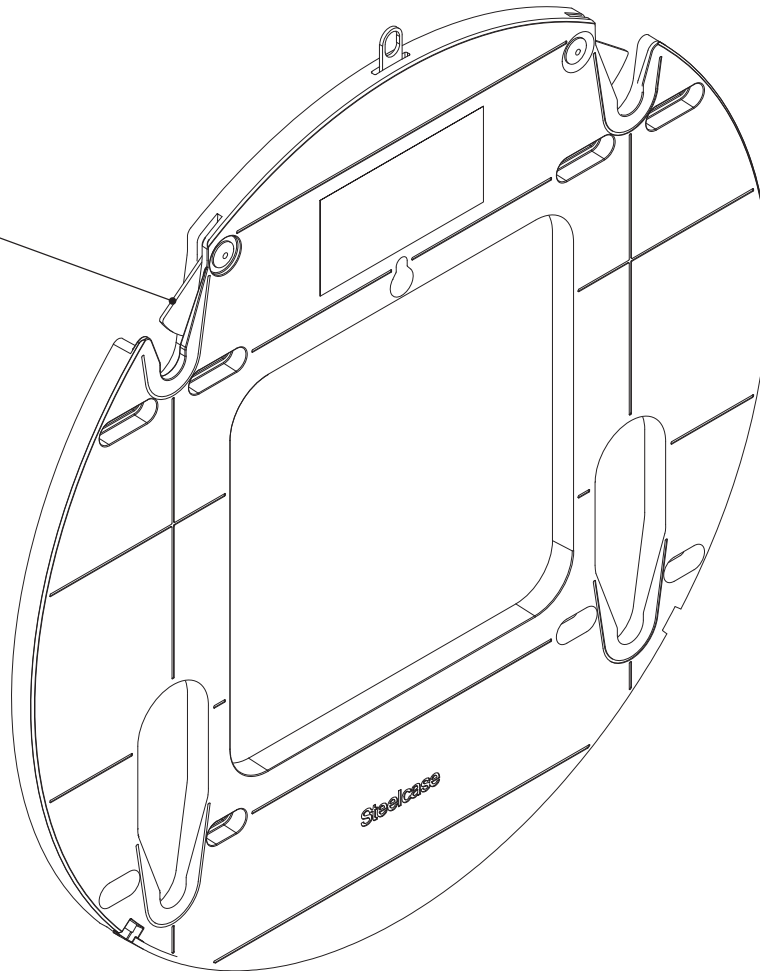

Surface Materials

Wall mount

- 6138 Microsoft Grey

Actual Dimensions

Overall diameter 22¹/₅"

Weight (without device) 7 lb

Thickness 5/8"

Roam Mobile Stand

For Microsoft Surface Hub 2



Tip: The Roam mobile stand can only be ordered through your AV partner—not through Steelcase.

Standard Includes	Required to Specify
-------------------	---------------------

- | | |
|--|---|
| <ul style="list-style-type: none"> ▶ Need help? Product details, page 2 | <ul style="list-style-type: none"> • Mobile stand • Two front locking casters • Two back non-locking casters • Water repellent tray |
|--|---|

Style number

Specification Information			
• Dimensions			• Style
• D	• W	• H	• Number
			• U.S. Price

30 ² / ₅ "	26 ¹ / ₂ "	65 ² / ₅ "	STPM1CART	\$1449



For Canadian Pricing

Multiply U.S. Price by the Canadian price factor.

▶ See page 1 for details.

Roam Single Wall Mount

For Microsoft Surface Hub 2

Roam Single Wall Mount

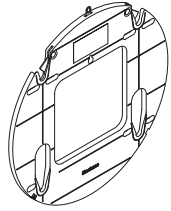

Tip: The Roam mobile stand can only be ordered through your A/V partner—not through Steelcase.

Standard Includes	Required to Specify
<ul style="list-style-type: none"> ▶ Need help? Product details, page 3 • Wall mount • Single mount hardware package 	<ul style="list-style-type: none"> Style number

Specification Information

• Dimensions	• Style	• U.S.
• Dia.	• Number	• Price
22 ¹ / ₅ "	STPM1WALLMT	\$249
:	:	:
:	:	:

Steelcase Roam

 **For Canadian Pricing**
 Multiply U.S. Price by the Canadian price factor.
 ▶ See page 1 for details.

Trademark List

- ® The following are registered trademarks for products of Steelcase Inc. or one of its related corporate entities: 4 o'clock, 900 Series, à la carte, Airtouch, Ally, Amia, Answer, Archipelago, Avenir, Ballet, Bix, Brayton International, Cachet, Canopy, Canto, Chancellor, Coalesse, Confidante, Context, Convene, CopyCam, Criterion, Crushed Can, Currency, dash, Designtex, Details, Detour, Drive, Elective Elements, Ellipse, Ember Chrome, Emerge, E-Table 2, FYI, Garland, Gentry, Ginkgo Biloba, Groupwork, Ideo, Jacket, Jenny, Jersey, Kart, Kick, LaCosta, Leap, Let's B, LiveBack, Max-Stacker, media:scape, Metro, Migrations, Mitra, Montage, Nurture, Oriana, Parade, Pathways, PCT, Permiso, Player, Portal, Power Pincher, Progeny, Protégé, R2, Rally, Relevant, Reply, Rizzi Arc, Sensor, Series 9000, Siento, Sieste, Sine, Softcare, Springboard, Steelcase, Steelcase Design Partnership, Stella, Stow Davis, Swathmore, TeamWork, Technique, Texpress, Think, Thunder, Topo, Train, turnstone, Underline, Unison, Vecta, Viridian, Walden, Werndl, and X-Stack.
- ® The following registered trademarks are under license from AWI Licensing Company, Dover, DE: SoundScapes, DuraBrite, BioBlock, and Armstrong.
- ® The following registered trademarks are under license from Byrne Electrical, Rockford, MI: Interport, Mini-Port, Axil Z, and Ellora.
- ® The following is a registered trademark of DuPont, Wilmington, DE: Corian.
- ® The following is a registered trademark of Genlyte Thomas Company, Louisville, KY: Lightolier.
- ® The following is a registered trademark of Hilti Corporation, FL-9494 Schaan, Principality of Liechtenstein: Hilti.
- ® The following is a registered trademark of Leviton Manufacturing Company, Little Neck, NY: Decora.
- ® The following is a registered trademark of Mechanical Plastics Corp, Elmsford, NY: Toggler.
- ® The following is a registered trademark of Microsoft Corporation, Redmond, WA: Microsoft.
- ® The following is a registered trademark of Panduit Corporation, Lockport, IL: Panduit.
- ® The following is a registered trademark of Trav (Press), Cuneo, Italy: Assisa.
- ® The following is a registered trademark of Virtual Ink, Boston, MA: mimioActive.
- ® The following registered trademarks are under license from Wilkhahn Furniture Products: Avera, Senzo, Versal, and Wilkhahn FS.
- ® The following is a registered trademark of Wilsonart International, Temple, TX: Chemsurf.
- ® The following is a registered trademark of Wiremold, West Hartford, CT: Wiremold.
- ® The following is a registered trademark of Security People, Inc.: Digilock.
- ® The following is a registered trademark of EMU Group S.P.A., Perugia, Italy: Emu.
- ™ The following are trademarks for products of Steelcase Inc. or one of its related corporate entities: Access, Active/Passive Shelf, Ainsley, Akira, Alcove, Alerion, Alight, Amaris, American Elect, American Tradition, ap40, Arbor, Arriva, Asana, Ascot, Aspekt, Astor, Await, Bassline, B-Free, Bira, Bivi, Bixby, Bottomline, Brody, Brook, Buoy, Burton, c:scape, Calla, Calm, Camber, Campfire, Capa, Cappuccino, Cesar, Chester, Chord, Circa, Clarendon, Classic Rectangular, Clipper, cobì, Collaboration, Community, Company, Convey, Cortex, Coupe, Crea, Crew, Cura, Cypress, Davenport, Dearborn, Deck, Déjà, Denizen, Denska, Derby, Divisio, Donovan, Dune, Duo, Echo, Edge, Elсна, Empath, Empress, Enea, êno, EnSync, Enviro, Escapade, Exchange, Exponents, Field, Flat Top, FlexFrame, Flip Top, Flute, Folio, FrameOne, FreeFlow, Frontier, Galilei, Gesture, Ginger, Ginkgo, Go Wall, Grip, Groove, Hatchback, Hawthorne, Hitch, Host Collection, Hosu, Huddleboard, i2i, Impact, Indy, InfoLink, IOS, I-Solve, Jack, Jarrah, Jetty, Juice, Kami, Kast, Kathryn, Lagunitas, Lark, L'Attitude, LearnLab, Leela, LessThanFive, Lincoln, Linden, LiveSeat, Loria, Lyric, Malibu, Malibu Too, Mansfield, Marathon, Martini, Mason, Masque, Migration, Millbrae, Mineral, Mingle, Mystic, Mystic Metal, Mystic Wood, Montara650, Montreal, Move, Nadia, Neighbor, nesso, Nickel, Nikko, Nod, Node, Norfolk, Ology, Ontrak, Oom, Opus, Orchid, Outlook Collection, Ovation, Paloma, Paperflo, Parliament, Pasio, Passerelle, Patriarch, Payback, Peek, Pile File, Pisa, Pool, Potrero415, PUCK, QiVi, Quba, Rave, Reed, Regard, Relay, Reunion, Ripple, Riser, Rocco, Rocky, RoomWizard, Runner, Satellite, Sawyer, ScapeSeries, Senti, Sentinel, Senza, Sequoia, Session, ShareLink, Shield, Shortcut, Sidewalk, SILQ, Skylar, Slumber, Smoke, Snug, Soft Leaf, Sonata, Sorrel, SOTO, Southside, Stationkits, Steelcase Series, Stiletto, Surprise!, Surround, Switch, Symphony, Sync, TagWizard, Tava, TeamStudio, TeamTheater, Tenaro, Terrazzo, Theorem, Thread, Topaz, Touchdown, Tour, Tower Too, Trees, Trillium, Trolley, tX2, U-Free, Umami, Underscore, Uno, V.I.A., Verb, Verge, Verlay, Victor2, Visalia, Waldorf, Woodruff, Workspring, and X-tenz.
- ™ The following is a trademark of Microsoft Corporation, Redmond, WA: Windows.
- ™ The following is a trademark of Rodman Industries, Inc., Oconomowoc, WI: ResinCore1.
- ™ The following is a trademark of Ultrafabrics, LLC, Elmsford, NY: Ultraleather.
- ™ The following trademarks are under license from Wilkhahn Furniture products: Cana, Linus, Logon, Picto, Range, Stitz, Thema, Timetable, and Tubis.
- ™ The following trademark is used under license from Cradle to Cradle Products Innovation Institute, Oakland, CA: Cradle to Cradle Certified.
- ™ The following trademarks are under license from Walter Knoll: Andoo, Bob, Lazlo, Lox, Ribbon, and Together.
- ™ The following trademarks are under license from PP Møbler: Bar and Flag Halyard.
- ™ The following trademarks are under license from Viccarbe: Davos, Holy Day, Last Minute, RS, Sistema, and Wrapp.
- ™ The following trademarks are under license from Carl Hansen: Elbow, Paddle, Shell, Wing, and Wishbone.
- ™ The following trademarks are under license from Cambridge Sound Management, LLC, Cambridge, MA: QtPro Soundmasking, Qt Quiet Technology, and Sonet Qt.
- ™ The following is a trademark of Electri-Cable Assemblies, Shelton, CT: Interact.
- ™ The following is a trademark of Clestra Hauserman: IRYS.
- ™ The following is a trademark of Wiesner-Hager Möbel GmbH: Nooi.
- ™ The following are trademarks of PolyVision: a³, e³, Motif, and PolyVision.

Trademarks used here in are the property of Steelcase, Inc. or of their respective owners.